

Introduction of LCD Display

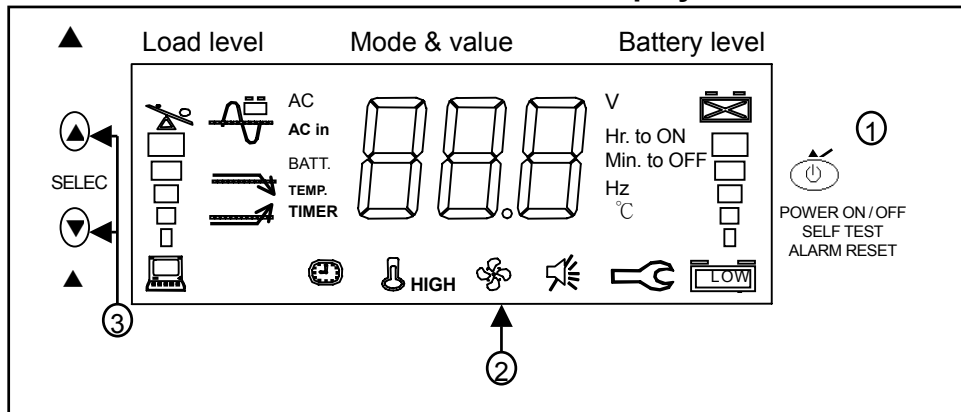

- ① Main control button.
- ② LCD screen.
- ③ Selection button for mode & value.

Note :









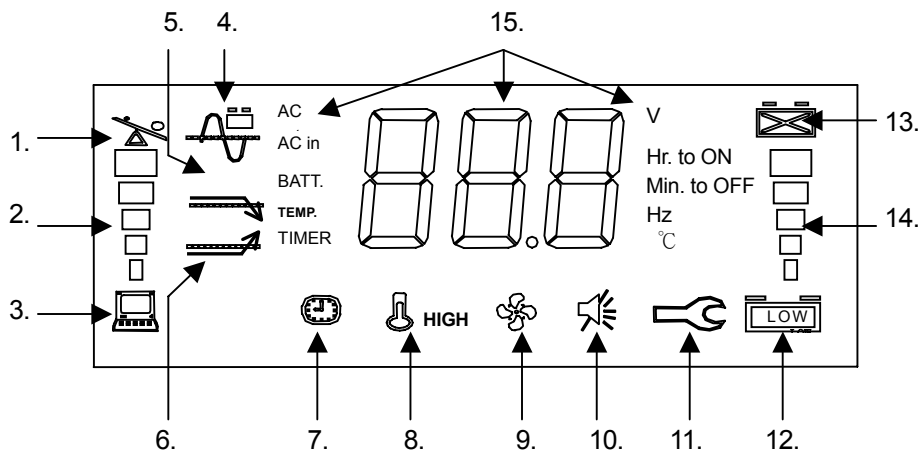



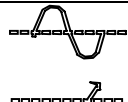

LCD available models:

All of our sine-wave line interactive UPS are suitable to be made with LCD display. These models include standard tower series, long-run tower series, standard rack mount series, & long-run rack mount series, etc.

1 Main control button: Please refer to point 4 & 5 of User's Manual.

2 LCD screen

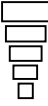

No.	Symbol	Indication	Description
1.		Over load	The loading exceeds the rating of UPS.
2.		Load level	The higher the loading, the more bars will illuminate.
3.		UPS is loaded	When "Green Mode" is enabled, this symbol will display if the loading is over 30W (approximately), and disappears when it is under 25W (approximately). Refer to User's Manual 4.3. If "Green Mode" is disabled, the symbol will always display.
4.		Normal mode	1) The sine wave symbol will display steadily without battery symbol when UPS is in the normal mode.
		Battery mode	2) The sine wave symbol and battery symbol will blink when the UPS is in back-up (inverter) mode.
		Test mode	3) The sine wave symbol will display steadily with blinking battery symbol when the UPS is in testing mode.
5.		Buck mode	The AVR (Auto Voltage Regulator) is reducing the output voltage of the UPS (when the input voltage is too high), and the sine wave symbol, as mentioned in item 4, will also display steadily to indicate that the output is in the normal mode.
6.		Boost mode	The AVR is increasing the output voltage of the UPS (when the input voltage is too low), and the sine wave symbol, as mentioned in item 4, will display to indicate it's in the normal mode
7.		Timer is enabled	This symbol will show up in the following situations: 1) A turn-on / turn-off schedule has been set using the monitoring software. Refer to User's Manual 5.6 and the "Readme" file or "Help" function of the monitoring software. 2) The Green Mode is enabled and the loading is under 25W (approximately). The UPS will turn itself off automatically in 30 seconds. Refer to 4.3 of User's Manual.
8.		Thermal alarm	The temperature inside the UPS is over 55°C. If the user does not reduce the load, the temperature will continue to rise and the UPS will shut down automatically at 60°C.
9.		Fan is in "High speed"	This symbol is used only for long run series and the 5000VA model. The symbol will display whenever the cooling fan is running at high speed, and will disappear at low speed.
10.		Alarm off	The audible alarm has been silenced. To reset the alarm in Back-up mode, push the control button (not available during low battery level in Back-up mode).
11.		UPS fault	The UPS has failed and must be repaired. Contact a qualified service person.
12.		Battery normal	1) In normal operation, this symbol indicates a charged battery.
		Battery low	2) When the battery charge level is low, the word "LOW" will be added to the symbol.

No.	Symbol	Indication	Description
13.		Battery replacement	The battery has failed and must be replaced. The battery is checked each time the Test Function is executed.
14.		Battery voltage level	<ol style="list-style-type: none"> 1) The higher the battery voltage, the more bars will illuminate. 2) When the UPS is charging the battery, the battery symbol and the level indicator will blink together.
15.	Mode	Value	Description
	AC out	V	AC output voltage.
	AC in	V	AC input voltage.
	AC out	Hz	AC output frequency.
	BATT.	V	DC battery voltage.
	TEMP.	°C	UPS internal temperature.
	TIMER	Min. to off	The UPS will turn off when the displayed value reaches zero. For example, if the timer shows 0.5 Min to off, the UPS will shut down in 30 seconds.
	TIMER	Hr. to on	The UPS will turn on when the displayed value reaches zero. For example, if the timer shows 48.0 Hr to on, the UPS will turn on in 2 days.
	BATT.	Min. to off	The estimated remaining run-time in Back-up mode. The accuracy of the value is influenced by the loading type, ambient temperature and battery condition (old or new).

3. Selection Button for mode & value.

All the operation data will be displayed on LCD screen. By selecting the required mode (upward or downward), the related value will be displayed.